

Data Sheet



Article number: 20065459

Description: E+G Lock knob GN 5339.5-40-M8-D-PL
St. steel

Measures

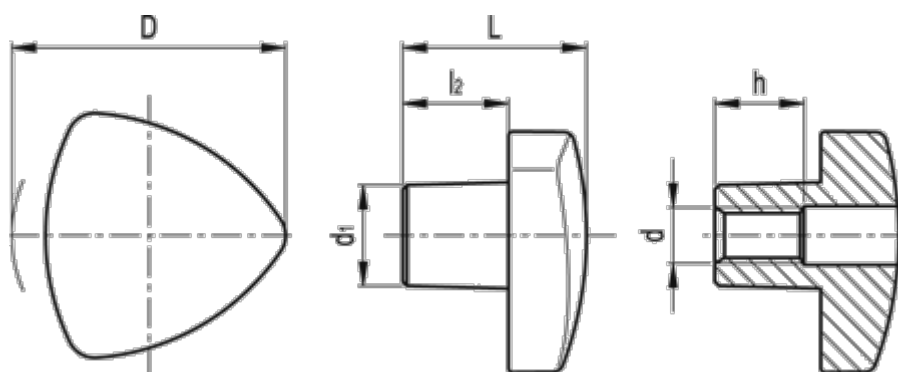

D	= 40
d	= M8
d1	= 14
h	= 13
L	= 26
l2	= 14
Weight (g)	= 90